



RTU DIGITAL INPUT MODULE TELEM-DI24-T User Manual

**Martem AS
2009**

Preface

This document, User Manual edition 1.1 for RTU (Remote Terminal Unit) Digital Input Module TELEM-DI24-T version 1.0, provides a general technical description of the module, its configuration and use. Although we have carefully checked the contents of this publication for conformity with the hardware and software described, we cannot guarantee complete conformity since errors cannot be excluded. The information provided in this manual is checked at regular intervals and any corrections that might become necessary are included in the next releases. Any suggestions for improvement are welcome.

The RTU Digital Input Module TELEM-DI24-T has been designed and manufactured according to the quality principles of ISO 9001.

TELEM is a registered trademark of Martem AS.

Contents

1. Application	3
2. Construction	3
3. Features	4
4. Technical Data.....	5
5. Mode Switches and Indication LED.....	5
5.1 Mode Switches	5
5.2 Indication LEDs	6
5.3 Setting an address.....	6
6. Loading Frame Program	6
6.1 Erase Flash from the Controller	6
6.2 To Load a New Frame Program.....	7
7. Configuration	7
7.1 Configurable Parameters and General Settings of Communication Ports	7
7.2. Configuration Parameters for Digital Inputs.....	8
7.3. Logical Operations with Digital Inputs.....	11
8. Connection to Signal Lines	12
9. Communication Cables.....	13

1. Application

TELEM-DI24-T digital input module is used for digital contact info acquisition, pulse counting and data exchange with higher level devices or systems. Its functionality allows it to be flexibly used for distributed process automation in systems to determine statuses of different objects or as a pulse counter where reliable information acquisition and excellent noise immunity with respect to environmental and electromagnetic influences are important. It may be used as a standalone device or in a daisy chain connection with other modules.

2. Construction

The mechanical design is based on a plastic box that can be readily mounted on 35-mm rails. The module is based on 32 ARM CPU. Interfaces to other equipment are RS-232 or RS-422. Data exchange protocol IEC 60870-5-1-101. Time synchronization is possible with synchronization pulse through a GW6 device.

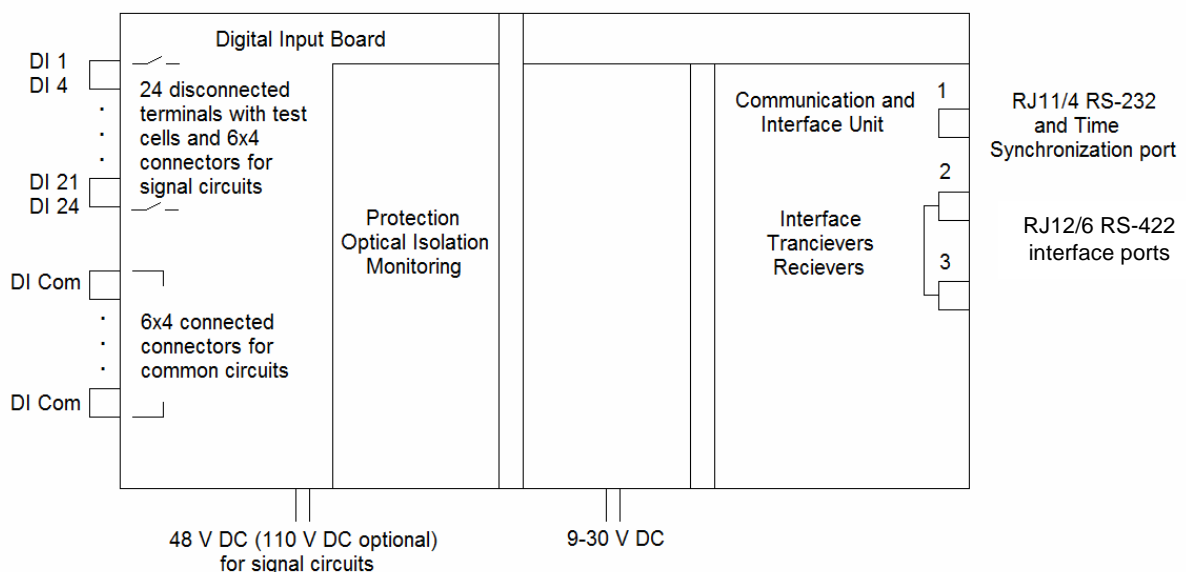

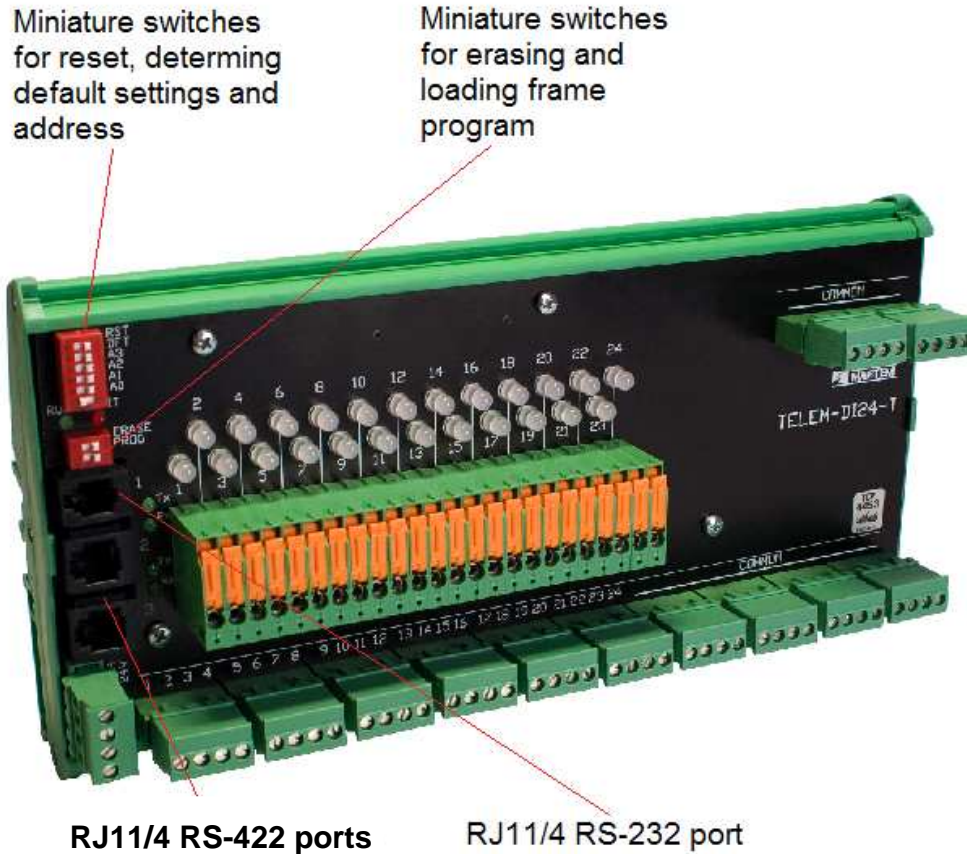

3. Features

- Time synchronization with 1 ms accuracy
- 2 level input filters - buffer depth for each time-tagged input is 20
- Logical operations with inputs
- Leased line or a dial-up mode operation, data GSM communication request by an event in substation or by the remote control centre
- Configuration / parameterization with IEC protocol at the same line with data communication
- Daisy chain master – slave connection of up to 15 same type of modules using RS- 422 interface and up to 45 different type of modules
- Self diagnostics and supervision simultaneously with data acquisition

4. Technical Data

Number of digital inputs	24
Indication	1 for every input, 1 for a running indication, 1 for an alert indication
Built-in clock with a backup capacitor	Yes
Supply voltage	9-30 V DC, 4 W
Isolated input circuit voltage for signal circuits	48V DC, 20 VA; 110V DC 50VA (optional)
Weight	495 g
Mounting	DIN 35
Dimensions (WxHxD)	250 x 120 x 60
Cross section of wires for signal	Max. 2,5 mm ²
Cross section of wires for power	Max. 2,5 mm ²
Terminal for communication	RJ4/4 (RS232); RJ12 (RS422)
Over voltage protection	IEC-60255-4, 5 kV pulse protection IEC-60255-5, 2 kV DC on
Disturbance	IEC-61000-3-2, 61000-6-2, 6100-6-4
Ambient temperature in operation	-20...+50°C

5. Mode Switches and Indication LED

5. 1 Mode Switches

Mode of operation, address of the module and the default settings are determined using switches on the board

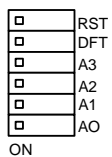

RST – ON - reset the device

DFT - ON- restores the default setup (see 7.1 and 7.2) after a reset

A0 - A3 - determines the address of the module (vide 5.3)

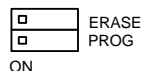

ERASE - ON erases the frame program (**be careful**)

PROG - ON loads a new frame program

5.2 Indication LEDs

Indication LEDs display the state of the device:

ALERT – fired, error state

RUN – blinking fire/unfired 1/1, normal operation and synchronized by an internal clock,

RUN – blinking fired/unfired 1/9, normal operation and synchronized by a gateway.

SIGNAL STATE – green fired, signal is activated, polarity of signal voltage normal,

SIGNAL STATE – red fired, signal is activated, polarity of signal voltage inversed.

5.3 Setting an address

A0	A1	A2	A3	Address
on	off	off	off	1
off	on	off	off	2
on	on	off	off	3
off	off	on	off	4
on	off	on	off	5
off	on	on	off	6
on	on	on	off	7
off	off	off	on	8
on	off	off	on	9
off	on	off	on	10
on	on	off	on	11
off	off	on	on	12
on	off	on	on	13
off	on	on	on	14
on	on	on	on	15
off	off	off	off	16

6. Loading Frame Program

6.1 Erase Flash from the Controller

- 1) switch ERASE to ON state
- 2) wait 2 seconds
- 3) switch RST to ON state
- 4) switch ERASE to OFF state
- 5) switch PROG to ON state
- 6) switch RST to OFF state
- 7) wait 5 seconds
- 8) switch RST to ON state
- 9) switch PROG to OFF state
- 10) switch RST to OFF state

6.2 To Load a New Frame Program

- 1) Download the SAM-BA.exe host program (AT91 In-system Programmer). The program can be downloaded from:
http://www.atmel.com/dyn/products/tools_card.asp?tool_id=3883
- 2) Install "AT91 In-system Programmer" running "Install AT91-ISP v.13.exe"
- 3) Specify paths to SAM-BA and bin files in "rtu_5_programming.bat" file. For instance:

```
echo Setting path to SAM-BA
path="C:\Program Files\ATMEL Corporation\AT91-ISP v1.13\sam-ba v
2.9";%path%
echo Setting path to user files
path="D:\Projects\RTU_ARM\RTU-T Firmware\V5";%path%
```

- 4) Specify the COM port, location of the SAM-BA core files and the "rtu_arm_di_501.bin" file. For instance if using COM 5 port:
set COMIF=COM5
- 5) Run "rtu_5_di_programming.bat"(Switches ERASE and PROG have to be in OFF state)
- 6) Waite until loading completing green colored message appears
- 7) Set default settings by switching.:
switch DFT ON state
switch RST ON/OFF state
switch DFT OFF state

7. Configuration

TELEM-DI24-T is configured using **TELEM module configuration** software. All 24 digital inputs are configured independently.

7.1 Configurable Parameters and General Settings of Communication Ports

- Transmission rate 200...38400 bit/s (default 9600 bit/s)
- Communication mode asynchronous data bits 8, parity N, stop bits 1
- Communication interface RS232, selectable RS422
- Communication protocol IEC60870-5-101 slave/master, unbalanced
- Link address length 1 byte
- ASDU address length 2 byte
- Object address length 2 byte
- GPS time synchronization input 9600 bps (RS422 RX),
- Time synchronization protocol ASCII (Motorola), device TLM-
- Communication interface isolation optically to 2,5kV RMS

7.2. Configuration Parameters for Digital Inputs

TELEM DI24T module is configurable by TELEM module configuration software or by other configuration software using the data exchange protocol IEC60870-5-101. Telem-2000 RTU configuration software runs under Windows 95 or later operating systems on any standard PC, communicates via COM interface and performs the following principal functions:

- Configuration / parameterization of RTU
- Back up of RTU configuration data

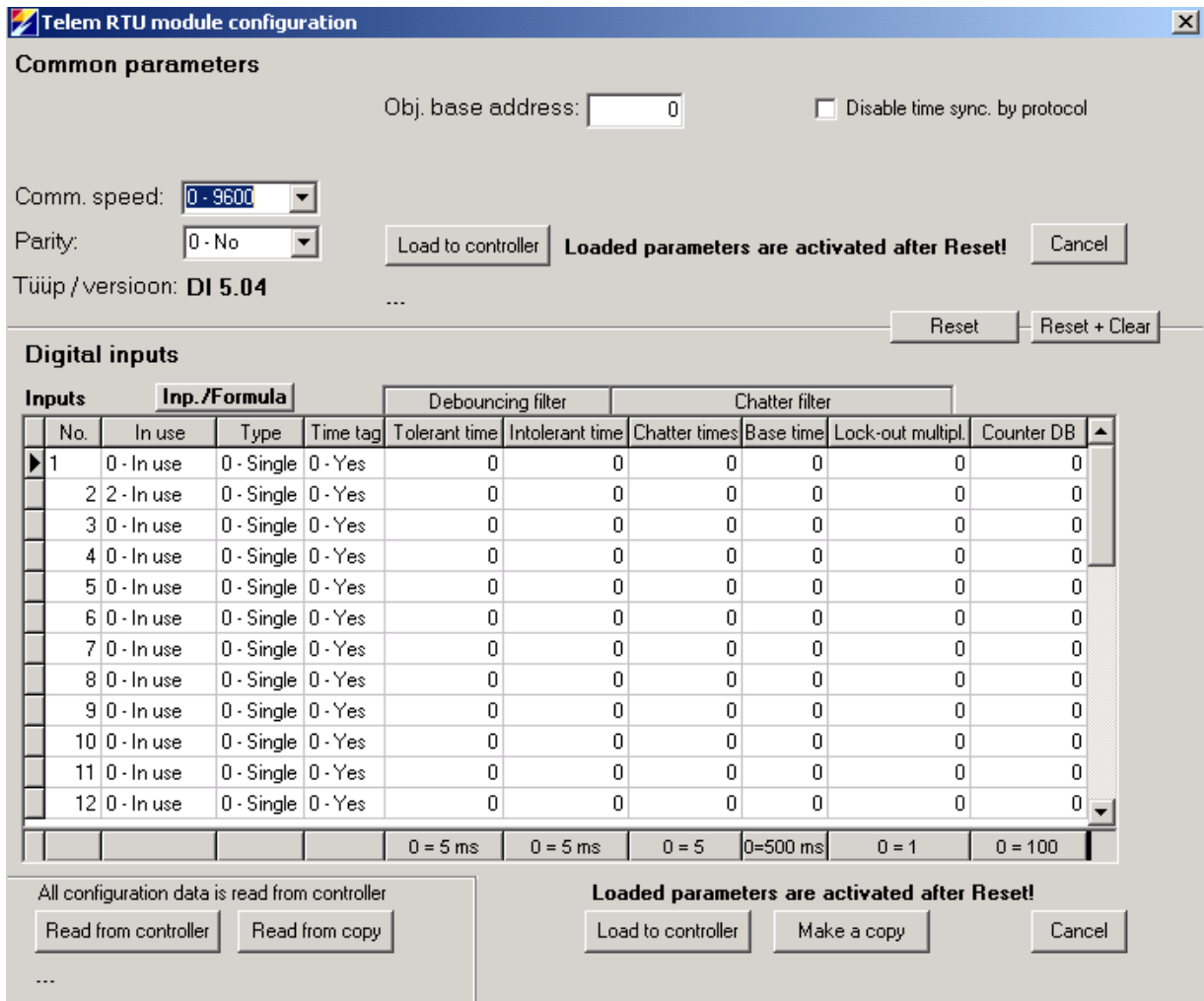

The screenshot shows the 'Telem RTU module configuration' window with the 'Digital inputs' tab selected. The 'Common parameters' section includes fields for 'Obj. base address' (0), 'Comm. speed' (9600), and 'Parity' (No). The 'Digital inputs' section contains a table with 12 rows, each representing an input channel. The table columns are: No., In use, Type, Time tag, Debouncing filter (Tolerant time, Intolerant time), Chatter filter (Chatter times, Base time, Lock-out multipl.), and Counter DB. Below the table, there are summary values for the filter settings. At the bottom, there are buttons for 'Read from controller', 'Read from copy', 'Load to controller', 'Make a copy', and 'Cancel'. A warning message 'Loaded parameters are activated after Reset!' is displayed.

No.	In use	Type	Time tag	Debouncing filter		Chatter filter			Counter DB
				Tolerant time	Intolerant time	Chatter times	Base time	Lock-out multipl.	
1	0 - In use	0 - Single	0 - Yes	0	0	0	0	0	0
2	2 - In use	0 - Single	0 - Yes	0	0	0	0	0	0
3	0 - In use	0 - Single	0 - Yes	0	0	0	0	0	0
4	0 - In use	0 - Single	0 - Yes	0	0	0	0	0	0
5	0 - In use	0 - Single	0 - Yes	0	0	0	0	0	0
6	0 - In use	0 - Single	0 - Yes	0	0	0	0	0	0
7	0 - In use	0 - Single	0 - Yes	0	0	0	0	0	0
8	0 - In use	0 - Single	0 - Yes	0	0	0	0	0	0
9	0 - In use	0 - Single	0 - Yes	0	0	0	0	0	0
10	0 - In use	0 - Single	0 - Yes	0	0	0	0	0	0
11	0 - In use	0 - Single	0 - Yes	0	0	0	0	0	0
12	0 - In use	0 - Single	0 - Yes	0	0	0	0	0	0
				0 = 5 ms	0 = 5 ms	0 = 5	0=500 ms	0 = 1	0 = 100

TELEM-DI24-T configuration tab card

Parameter	Value	Default value
General		
1. In use	Yes No	Yes
2. Single- or double signal or counter input [In case of double signal the next input is used for second signal]	Single Double	Single
3. Time tagged	Yes No	Yes
Debouncing filter		
4. Tolerant phase [A period of time during which changes of state are permitted and ignored on a digital input signal]	1-255 ms.	5 ms (0)
5. Intolerant phase [A period of time during which the state of a digital input must remain constant]	1-255 ms.	5 ms (0)
Chatter filter [A facility that is used to disable a digital input point if the number of state changes of that point is excessively high during a defined time interval]		
6. Chatter times [changes]	1-255 times	5 (0)
7. Filter base [defined time interval]	0-32000 ms.	500 ms (0)
8. Lock-out period multiplier [Number of filter base periods when the chatter filter will be on]	1-255 periods	1
Counter		
9. Number of pulses for creating an event [Counter event is always without time tag]	1-255 pulses	100 (0)

Digital input processing

Debouncing filter

Tolerant phase: A period of time during which contact bounce is “acceptable”. Having a tolerant period allows you to monitor and time-stamp the initial state of change while ignoring any subsequent contact bounces.

Intolerant phase: A period of time following the tolerant phase during which contact bounce is not “acceptable”. It ensures that contact bounce is not mistaken for a valid change of state.

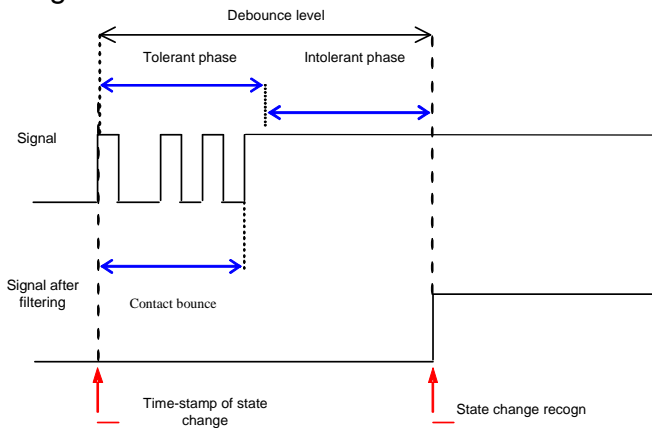

Chatter filter

Chatter times (changes): The maximum allowed number of state transitions that can occur within a filter base period. If the number of state transitions during a filter period equals or exceeds the maximum allowed number of state transitions, chatter filter will turn ON and any further transitions will be ignored for the duration of the “lock-out” period.

Lock-out period: The minimum number of filter base periods during which the chatter filter will remain ON. The chatter filter can proceed from ON to OFF only if no state transitions are detected during the entire lock-out period.

Example: Chatter times (changes) 5, Lock-out period 1

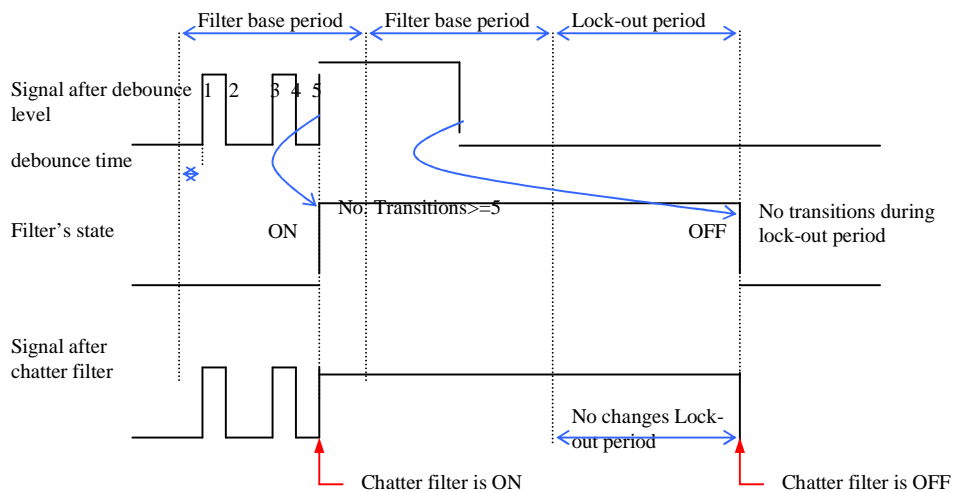

7.3. Logical Operations with Digital Inputs

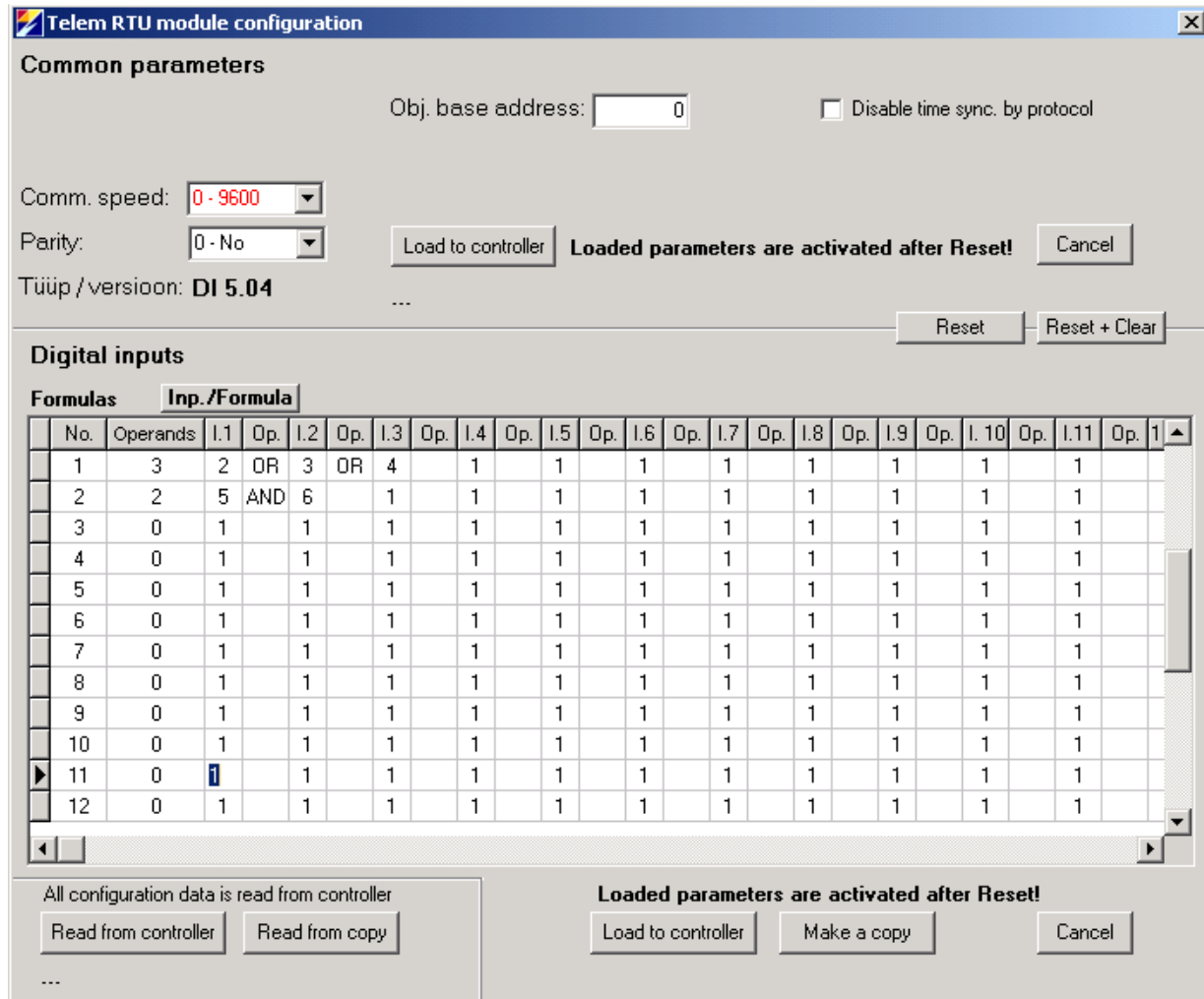

Telem RTU module configuration

Common parameters

Obj. base address: Disable time sync. by protocol

Comm. speed:

Parity: **Loaded parameters are activated after Reset!**

Tüüp / versioon: **DI 5.04**

Digital inputs

Formulas **Inp./Formula**

No.	Operands	I.1	Op.	I.2	Op.	I.3	Op.	I.4	Op.	I.5	Op.	I.6	Op.	I.7	Op.	I.8	Op.	I.9	Op.	I.10	Op.	I.11	Op.	I.12
1	3	2	OR	3	OR	4		1		1		1		1		1		1		1		1		1
2	2	5	AND	6		1		1		1		1		1		1		1		1		1		1
3	0	1		1		1		1		1		1		1		1		1		1		1		1
4	0	1		1		1		1		1		1		1		1		1		1		1		1
5	0	1		1		1		1		1		1		1		1		1		1		1		1
6	0	1		1		1		1		1		1		1		1		1		1		1		1
7	0	1		1		1		1		1		1		1		1		1		1		1		1
8	0	1		1		1		1		1		1		1		1		1		1		1		1
9	0	1		1		1		1		1		1		1		1		1		1		1		1
10	0	1		1		1		1		1		1		1		1		1		1		1		1
11	0	1		1		1		1		1		1		1		1		1		1		1		1
12	0	1		1		1		1		1		1		1		1		1		1		1		1

All configuration data is read from controller

Loaded parameters are activated after Reset!

TELEM-DI24T Formulas Tab Card

It is possible to configure formulas where inputs are combined with NOT, AND, OR and XOR operations.

When formulas are used, every formula occupies one IEC protocol object address of inputs (substitutes the input).

By their default, IEC objects and inputs are bound with the following formulas:

$$Y1 = X1$$

$$Y2 = X2$$

$$\dots Y24 = X24 \text{ Where X is input and Y is the calculated value.}$$

8. Connection to Signal Lines

Layout of the terminals of digital input signals

