



Data Concentrator TELEM-AGC

User Manual

Martem AS
2019

Contents

- 1. INTRODUCTION 3
- 2. FEATURES 3
- 3. TECHNICAL DATA..... 5
- 4. TERMINAL CONNECTIONS 7
- 5. COMMUNICATION CABLES 8
- 6. FIRMWARE UPDATE 10
- 7. USING CONFIGURATION FROM SD CARD..... 11
- 8. DIP SWITCHES..... 11
- 9. INDICATION LED-S..... 11
- 10. CONFIGURATION TOOL 11
- 11. DATA OBJECTS SIMULATOR 12
- 12. ORDER CODE 13
- 13. MAINTENANCE GUIDELINES..... 14
- 14. OPEN-SOURCE SOFTWARE INFORMATION 14

1. Introduction

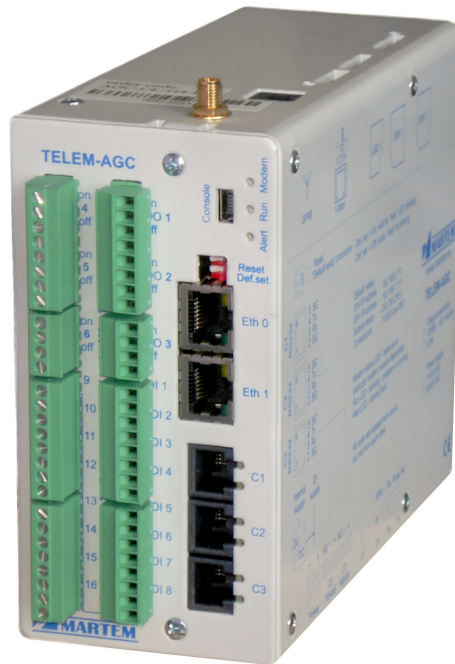

TELEM-AGC is designed for use in electrical networks as communication concentrator, firewall and 4G/3G/2G modem. The software bases on Linux operating system.

Main usage is communication device and RTU (Remote Terminal Unit) in electrical substations for data exchange between various substation devices and control centres.

In accordance with modification it can be 4G/3G/2G modem and firewall or also data concentrator with RTU functionality.

The hardware modifications include digital IO signals, additional networking and serial interfaces.

The construction does not include moving parts as fans, rotating hard disk drives. For data storage the internal Flash memory and SD card is used.

2. Features

- Transparent TCP/IP connections via Ethernet and serial ports
- Various data exchange protocols via Ethernet and serial ports
- Cross-referencing of data exchange protocols
- Events (binary object's value changes) are buffered for case of possible communication failure. Every binary object has buffer with size of 20 events, so the total size of events buffer is no. of BI objects x 20

- Automatic protocol conversion from IEC 60870-5-101 to IEC 60870-5-104 without description of data objects.
- Firewall functionality
- OpenVPN, IPsec, L2TP and SSH connections
- SNMP (Simple Network Management Protocol)
- LDAP (Lightweight Directory Access Protocol)
- SDN (Software Defined Networking)
- DPI (Deep Packet Inspection)
- Logging of security events as remote connection and login attempts, RTU hardware and firmware errors to *messages* (syslog) and *console.log* files
- Graphic Web Server
- A user-friendly free configuration tool
- Configurable remotely over communication line
- Configuration export to ASCII, CSV format files
- Configuration can be stored in SD card, which can be used in replacement RTU
- TELEM RTU devices can be remotely configured via TELEM-AGC
- Logical operations between digital and analog signals
- Data sending with time and quality stamp
- Several time synchronization options (possible to synchronize from multiple control centers. TELEM-AGC is used to synchronize substation devices by protocol)
- GPS input
- **NTP and PTP (IEEE1588v2) client and server**
- Up to 5 Ethernet ports, 7 serial communication ports, all ports are galvanically isolated from case and power circuit
- Up to 16 digital inputs 6 double digital outputs (12 output relays)
- 1-wire sensor port (up to 10 sensors) e.g. for temperature sensor
- Real-time clock with back-up capacitor
- Support of predefined and dynamic data sets
- Support of Parallel Redundancy Protocol (PRP)
- No of I/O datapoints is not restricted, tested with 6000 I/O datapoints
- Console port

3. Technical Data

Data communication protocols

To higher level systems:

- IEC 60870-5-104
- IEC 60870-5-101 unbalanced and balanced,

To lower level devices:

- IEC 60870-5-104,
- IEC 60870-5-103,
- IEC 60870-5-101 Unbalanced,
- Modbus-RTU,
- Modbus-TCP,
- IEC 62056-21 (IEC 1107),
- SPA-Bus
- IEC 61850 (licence can be linked to SD card and transferred to another RTU)

Communication ports

Depending on hardware configuration TELEM-AGC can have up to 5 Ethernet ports, and 7 serial communication ports.

Ports can be freely configured for upper or lower level communication.

Base board interfaces

- 2 x Ethernet connection with RJ45 port. 1,5kV isolation
- 1 x RS-232 with RJ12-6P6C connector, galvanically isolated. 15 kV surge protection
- 2 x RS-485/232 ports with RJ12-6P6C connectors for RS-232 and screw terminals for RS-485, galvanically isolated. 15 kV surge protection
- 1 x Console mini USB port
- 1 x optical RS232 or GPS port
- 1-wire for environmental sensors

Expansion modules

- Module C
 - 4 x RS-485/232
- Module D
 - 8 optically isolated dry contact digital inputs (connected to dry contacts)
 - 3 double digital outputs (relay contacts max. 0.3A 110VDC, 2A 30VDC, 0.5A 125VAC)
- Module L 3 x RJ45 Eth.
- Module O 2 x Optical Eth. + RJ45 Eth.

Serial data communication parameters

- 1 start bit
- Odd, even or no parity
- Communication rates from 300 to 115200 bit/sec

Electrical characteristics of isolated input

- Dielectric withstand IEC 60255-5
- Withstand to static discharge IEC 61000-4-2
- Withstand to surges, bursts IEC 61000-4-4, 61000-4-5

Mechanical parameters

- Degree of protection IP 31
- Dimensions W x H x D (without connectors) 67 x 148 x 190 mm
- Ambient temperature in operation -40 °C...+70 °C
- Weight 900 g
- Mounting DIN rail
- Relative humidity 95% non-condensing

Radio frequency compatibility

- RF emission IEC 55022 Class A
- Immunity to RF fields IEC 61000-4-3, 61000-4-6

Power supply

- Supply voltage range 11...33 or 20...60 V DC
- Power consumption < 7 W, < 18 W with optical Eth.

4. Terminal Connections

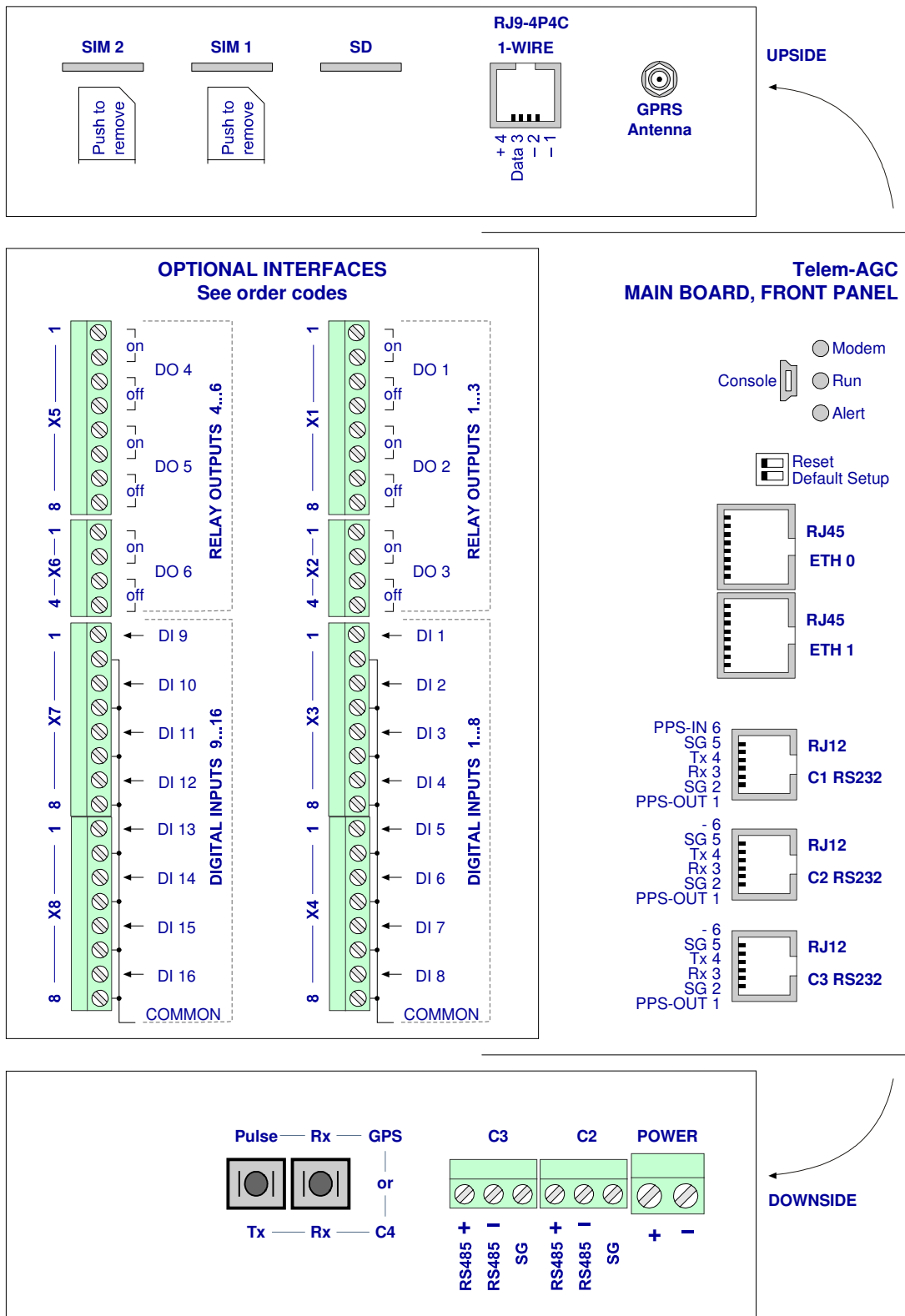

5. Communication cables

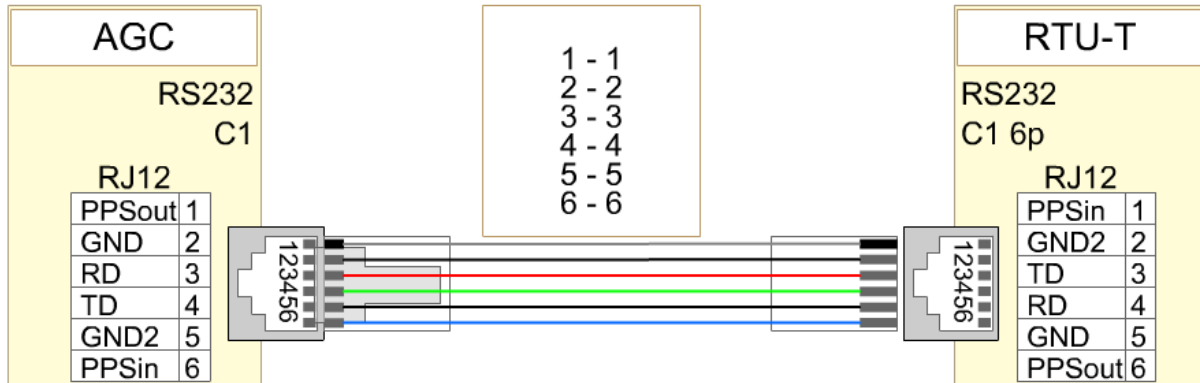

The newer models of RTU-T have 6 pin RJ12 RS232 connectors, older - 4 pin RJ9

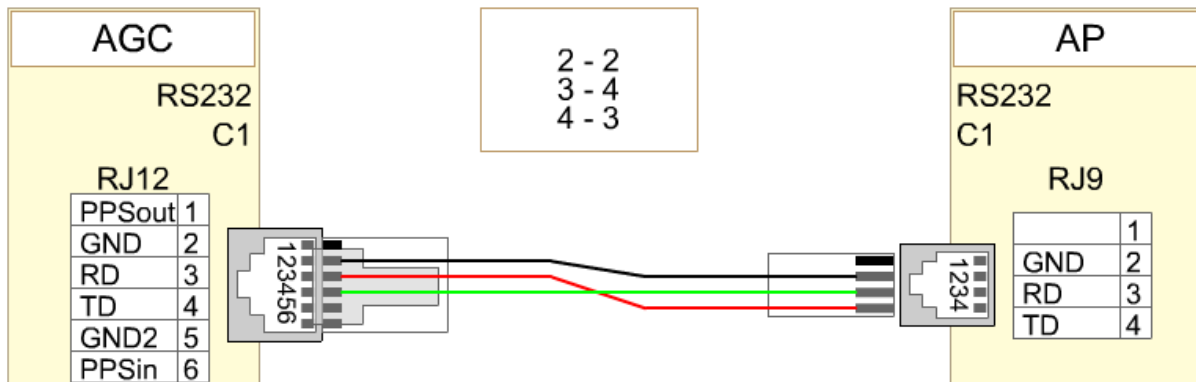
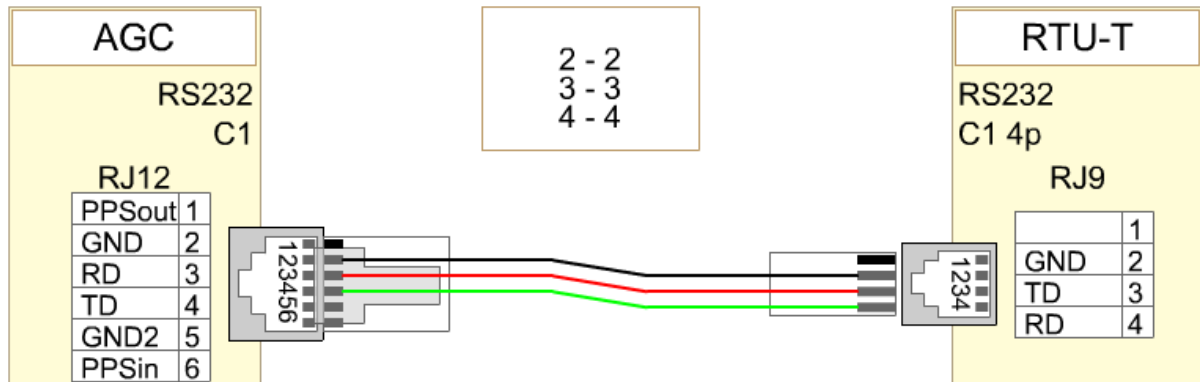

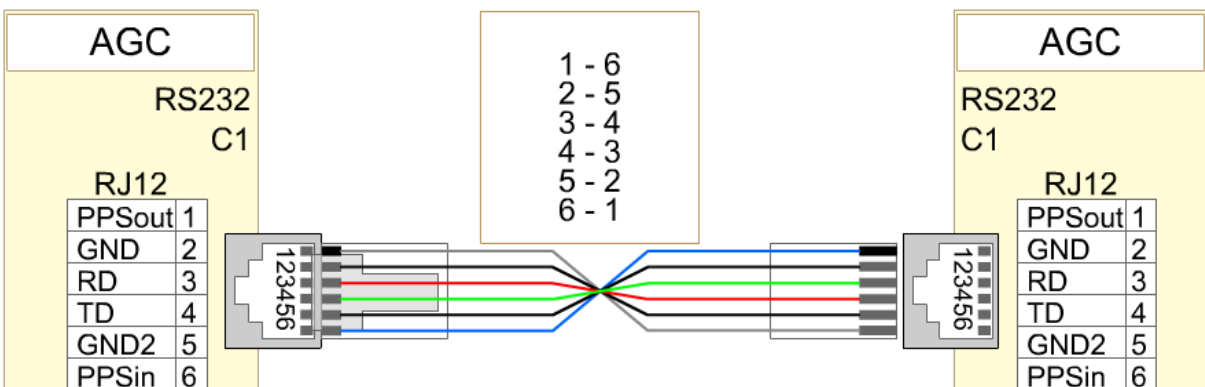
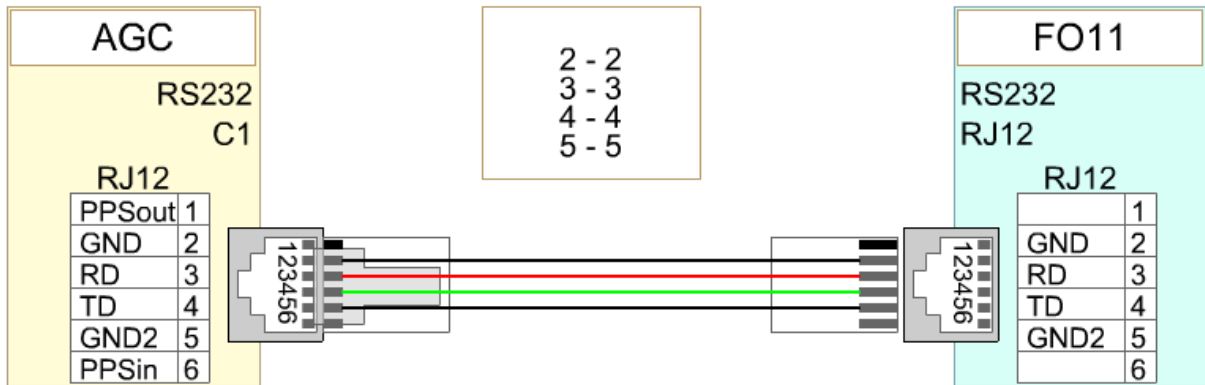
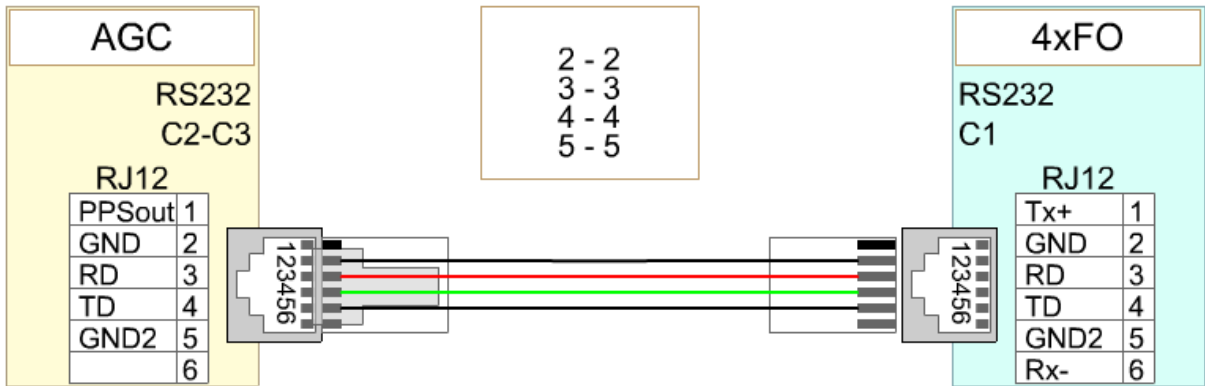

6. Firmware update

NB! Before updating to new firmware read the setup from your device, and make a backup.

- Run **GWS.exe** and set up SSH connection with the device
- Press the **Upd▼** button next to **R W C** buttons
- If you have compressed .7z firmware update file (provided by Martem AS) choose **Update From File**

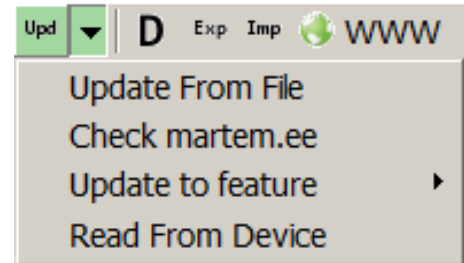

- If you do not have .7z firmware update file choose **Check martem.ee** to refresh existing firmware versions list for this AGC-L device
- Press **Update to feature** and choose needed firmware version. Download is starting...
- After firmware is downloaded **Confirm** window appears. Press **Yes** button, the update process starts
- Wait until the device resumes to its normal operation state (**RUN** LED will start slow blinking again), firmware update is complete.
- If a SD card is in it's slot when firmware updated over SSH the new firmware will be copied also to SD card

Checking results of the firmware update operation:

- Press **R** button to read back the device setup data
- Check the **Version** from **GWS Status** tab

Reading firmware back from device:

- Press the **Upd▼** button and choose **Read From Device**
- Follow dialog messages for uploading firmware.7z file

Updating firmware from SD card:

- Put SD card with firmware into it's slot (firmware.7z file must be placed to SC card folder gwupd)
- Reboot AGC device to start firmware update

7. Using configuration from SD card

- Put SD card with config.tar.xz into its slot (config.tar.xz must be placed in SD folder "config")
- Reboot AGC device for loading configuration from SD card
- If a SD is in slot when configuration is loaded to AGC device over SSH (using GWS) the new setup.tar.xz will be written also to SD card folder "config". the previous setup.tar.xz will be renamed to setup.tar.xz.0 (previous setup.tar.xz.0 to setup.tar.xz.1 and so on)

8. DIP switches

Reset: Switch RESET to ON state and then back to OFF state for Reset operation

Dft. Set: To apply default setup:

1. Switch DFT. SET to ON state

*Alert indication LED starts blinking within 5 seconds

*Alert indication LED will blink for 2 seconds

2. Switch DFT. SET back to OFF state when the alert indication LED **is blinking** to apply default setup

*If DFT. SET is switched back to OFF state when the alert indication LED is not blinking, default setup will NOT be applied

9. Indication LED-s

MODEM – green LED – indicates the 4G (3G) modem network connection

RUN – green LED – blinking green indicates that the program is running

ALERT – red LED – failure

Green LED-s on serial communication ports for RX, TX indication.

10. Configuration tool

The Telem-AGC device is configured with Telem-GWS software.

The configuration process is described in Telem-GWS software manual

11. Data objects simulator

The values of measurement objects of IEC 61850 and other protocols can be simulated on RTU's web page for testing the communication between RTU and SCADA

- Open web page with address [AGC device IP]/index2.html
- Select the device for object's simulation
- Press "Options" - "Enable Simulation" - "YES"
- Select measurement object from table - simulation window opens
- Set value for analog or binary signals and then press "Execute" (Value of binary signals could be changed also from buttons "ON" and "OFF")

The screenshot shows the TELEM device monitor web interface. The browser address bar displays `172.16.0.177/index2.html#`. The interface includes a navigation menu with options like Channels, Port1, Device1, GWMIO, IEC-104 up, and WebServer. The main content area shows the 'Options' section with 'Enable Simulation' set to 'Yes'. Below this is a table of measurement objects:

AI	5	AI 1	0.423
AI	6	AI 2	0.162
AI	7	AI 3	0.493
DI	11	DI 1	2
DI	12	DI 2	1
DI	13	DI 3	2

Two simulation windows are open. The 'AI 1' window shows a 'Set value' of 0.999. The 'DI 1' window shows a 'Set value' of 0, with 'OFF' and 'ON' buttons available for binary signals.

12. Order code

TELEM-AGC-XX-XX-XX-(XX)

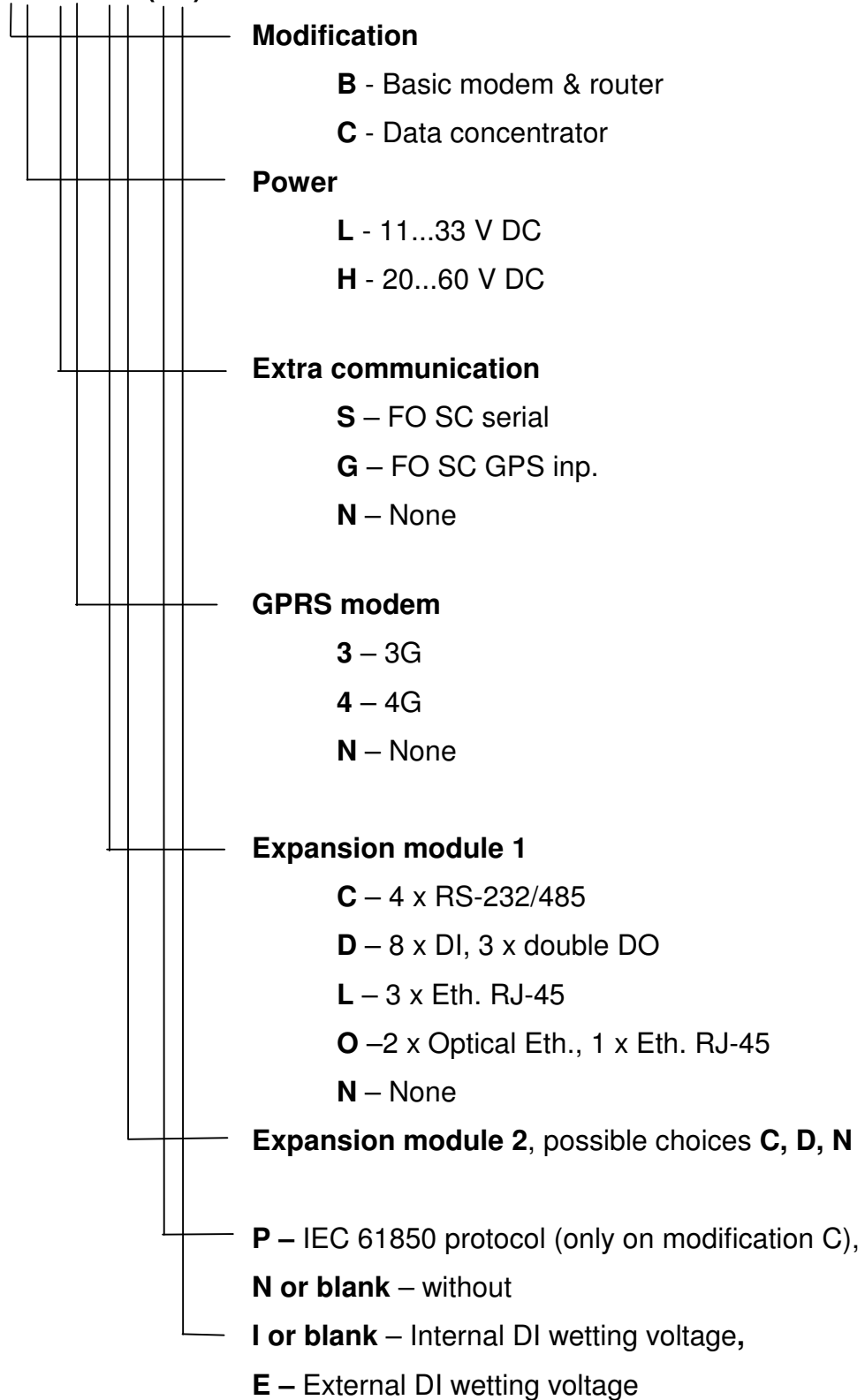

13. Maintenance guidelines

Device does not have any moving parts and does not need attention regarding mechanical wearing.

Maintenance consists of checking the *messages* (syslog) and *console.log* files for possible errors. Log files can be acquired using GWS configuration software.

For monitoring the health of the device it can be tied to SNMP server software which eliminates the need for periodical maintenance.

14. Open-source software information

This device produced by Martem includes open-source components. The most up to date info of exact software used by Martem's build system and licensing info of used software can be found from <http://phobos.martem.ee/shr/br-sources/>